



| ROMI DCM 620-5X | ROMI DCM 620-5F

VERTICAL MACHINING CENTERS - 5-AXIS / 5-SIDED

# **ROMI DCM 620** SERIES

**ROMI Industrial Complex, in  
Santa Bárbara d'Oeste - SP, Brazil**



## INNOVATION + QUALITY

### **ROMI: Producing high quality technology since 1930.**

Since the beginning, Romi has been recognized for its focus on creating products and innovative solutions which has guaranteed its technological leadership among large manufacturers of machine tools. Romi's industrial complex is among the most modern and productive sites in the fields of machine tools, plastic processing machines, and high quality cast iron parts.

### **Continuous investments in Research & Development result in products with state-of-the-art technology.**

The technology applied to Romi machines offers highly reliable products, with high accuracy, efficiency and great flexibility for several types of machining processes. Romi R&D is focused on increasing competitiveness for its customers.

### **Present throughout Brazil and in over 60 countries.**

Romi covers all domestic territory through its sale subsidiaries network fully prepared to support customers by supplying an extensive range of services from marketing to after sales assistance. The international market is covered by Romi's subsidiaries which are located in the United States, Mexico, Europe, and by its many dealers located in strategic logistic centers around the globe that are capable of serving customers in 5 continents.



Plant 16

## ROMI DCM 620 SERIES



ROMI DCM 620-5F



ROMI DCM 620-5X

**High technology for complex geometries, best machining strategy choice and productivity increase.**

ROMI DCM 620 Series consists of advanced vertical machining center with 5-axis / 5-sided, designed for machining parts with both simple and complex geometric aspects at high speeds. The machining configuration with 5-axis simultaneous or 5-sided allows machining of complex parts in a single setup. This will significantly reduce machining time and increase efficiency, precision, and productivity.

Flexibility, efficiency, accuracy and productivity for machining parts in one single set-up.



**ROMI DCM 620-5X**

- Headstock: 15.000 rpm
- Spindle taper: ISO 40
- Main motor: 24 hp / 18 kW
- Automatic tool changer: 30 tools capacity
- Rotary table: 600 x 600 mm (26x26")
- CNC Siemens Sinumerik 840D



**ROMI DCM 620-5X**

**Power Graph**

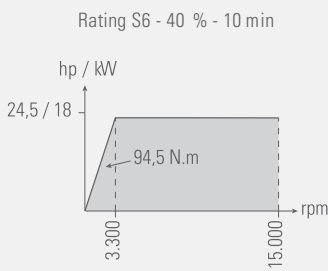

**Machine dimensions**

dimensions in mm (in)

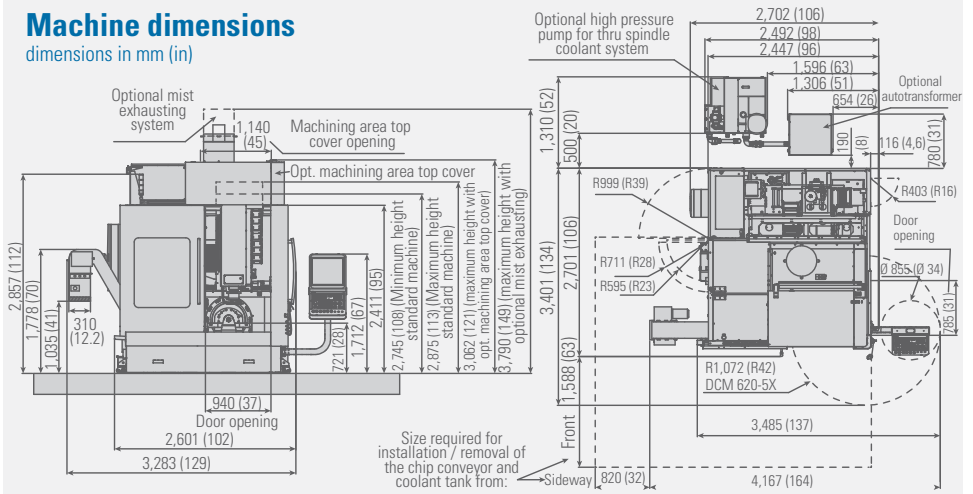



Flexibility, efficiency, accuracy and productivity for machining parts in one single set-up.



**ROMI DCM 620-5F**

- Headstock: 10.000 rpm
- Spindle taper: ISO 40
- Main motor: 24 hp / 18 kW
- Automatic tool changer: 30 tools capacity
- Rotary table: 600 x 600 mm (26x26")
- CNC Siemens Sinumerik 828D

**ROMI DCM 620-5F**

**Power Graph**

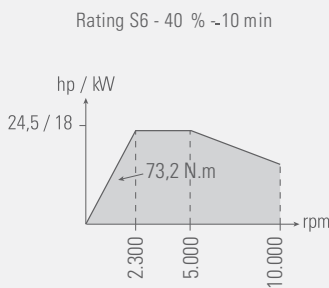

**Machine dimensions**

dimensions in mm (in)

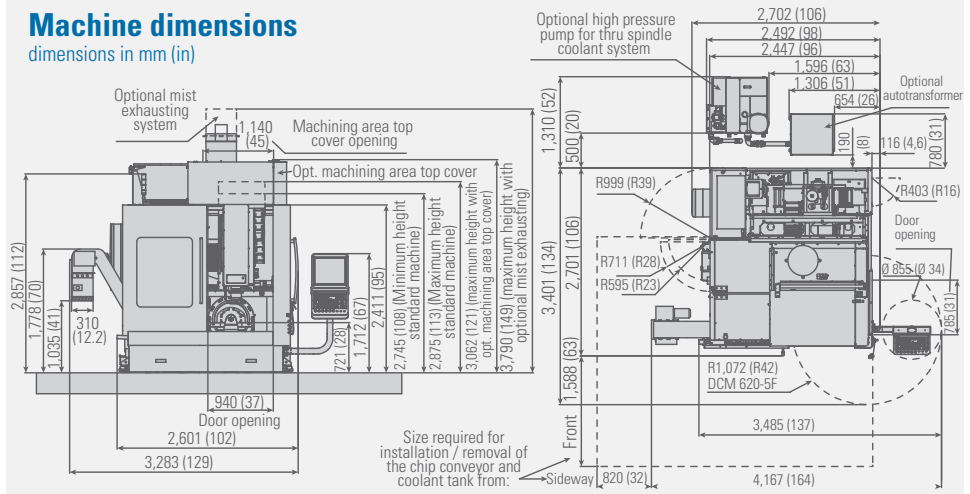



## THERMAL COMPENSATION

Strategically placed on the machine, mathematical algorithms correct the position of the axes in real time. In this way, stable dimensional results are obtained, even for long periods of time.

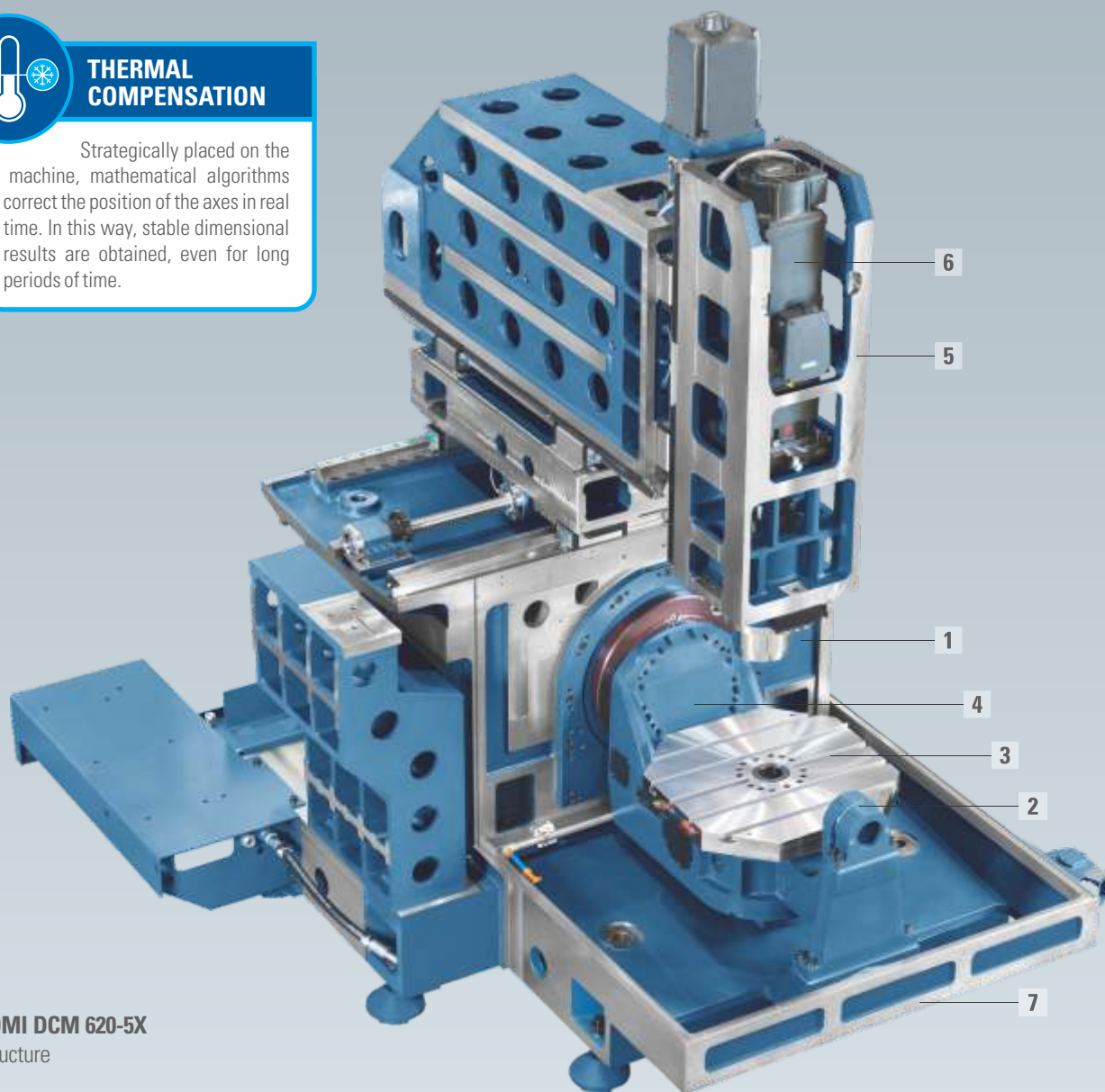

**ROMI DCM 620-5X**  
Structure

## STRUCTURE

### 1 Headstock

Spindle cartridge is directly coupled to the main motor (direct drive) with great efficiency in power and torque transmission. It presents the advantages of low noise and elimination of gaps and vibrations if compared with pulleys and belt transmission system. Offers maximum rotation of 10,000 rpm (ROMI DCM 620-5F) and 15,000 rpm (ROMI DCM 620-5X), ensuring excellent performance under severe cutting conditions in machining operations at full power.

### 2 Support bearing

It assures complete rigidity of the table in operations with heavy loads.

### 3 Rotary table (C axis)

It enables pieces positioning in any part of the table, 360°.

### 4 Tilting table (B axis)

It supports the rotary table and enable its positioning from -110° up to +110° (\*).

### 5 Column

With robust structure it supports the headstock assembly. The column is supported on linear roller guides which offers high rigidity and enables high speed displacements.

### 6 Main motor

It is directly coupled to the spindle cartridge ensuring great efficiency in power and torque transmission.

### 7 Base

It is robust and made of cast iron. It supports the table assembly, comprised of B and C axes, column assembly and headstock assembly. X, Y and Z axes have linear roller guides which offer high rigidity, stability, positioning accuracy and high quality surface finishing for machining processes with maximum efficiency and productivity.

(\*) Machines equipped with tool preset the angle becomes +80°.



Work area  
ROMI DCM 620-5F

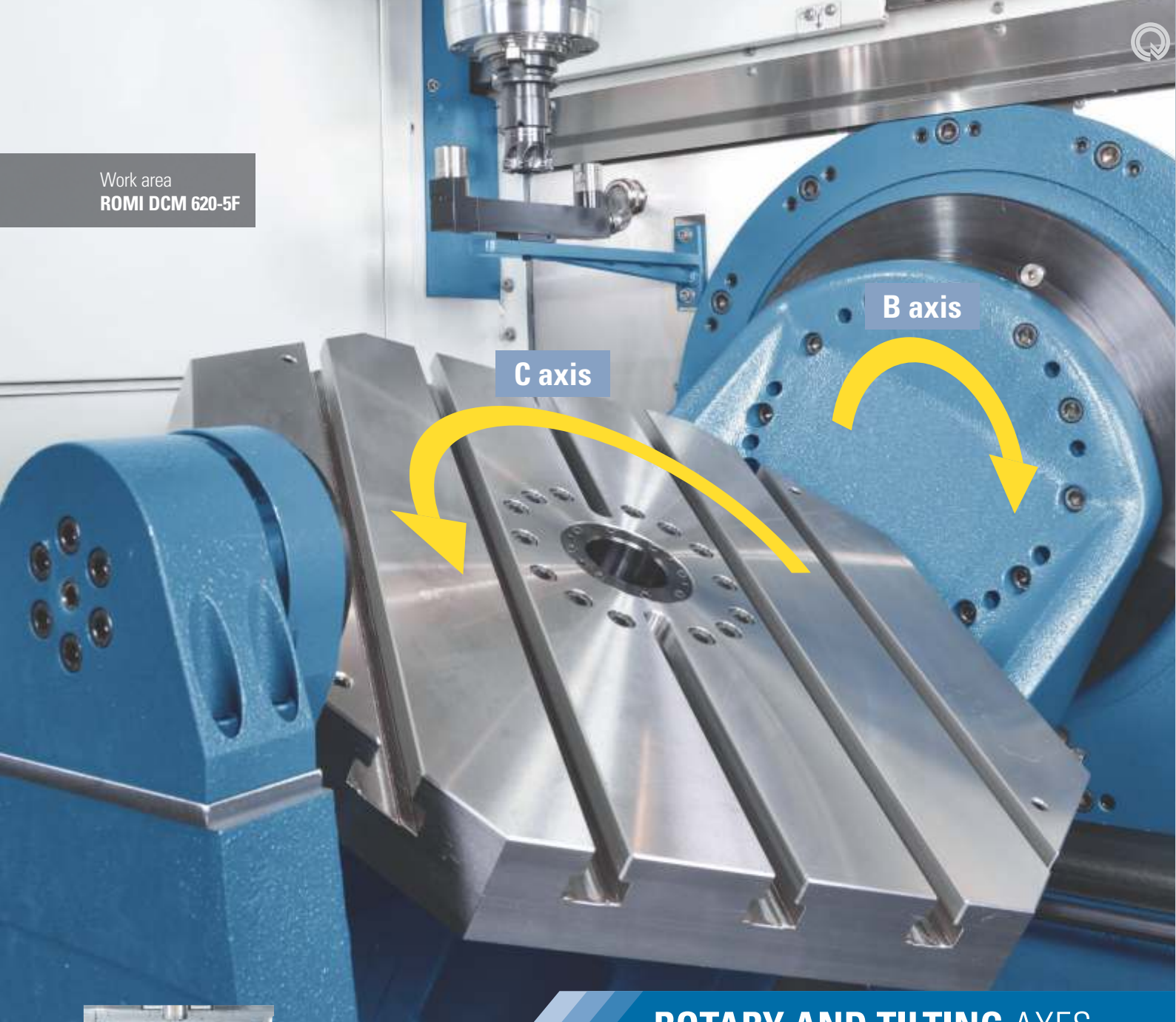

## ROTARY AND TILTING AXES

### Rotary axis (C axis) and tilting axis (B axis) ROMI DCM 620-5F

Rotary / tilting table offers high rigidity, assuring great precision in 5 faces machining with millesimal angular positioning to achieve the result of very precise high complexity parts.

### Rotary axis (C axis) and tilting axis (B axis) ROMI DCM 620-5X

Rotary / tilting table offers high rigidity. It is equipped with linear encoders assuring great precision in simultaneous machining of 5 axes, with millesimal angular positioning, to achieve the result of very precise high complexity parts.

#### B and C axes characteristics

- B axis tilting angle: - 110° to +110° (\*)
- C axis rotary angle: 360°
- B and C axes are driven by independent motors

- Maximum weight allowed on the table  
B and C axes: 300 kg (660 lbs)
- B and C axes rotation: 12 rpm
- Clamping force: B axis = 4.410 N.m  
C axis = 2.450 N.m

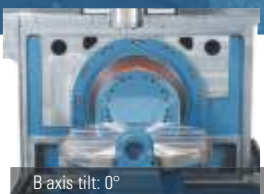

B axis tilt: 0°



B axis tilt: -110°



B axis tilt: +110°

(\*) Machines equipped with tool preset the angle becomes +80°.

## Headstock

Direct-drive Spindle – it's directly attached to the spindle cartridge.

The direct-drive system is highly efficient because it maintains high-performance in acceleration and deceleration. It generates a low amount of noise, eliminates gaps and dampens vibrations.

It also features high-quality operations with rigid tapping.

## Excellent thermal insulation project

Thermal insulation system of the headstock minimizes displacements caused by heating offering high precision spindle positioning and long durability for the assembly. Coupling between motor and spindle is also isolated, and combined with headstock cooling system, thermal distortions are minimized.

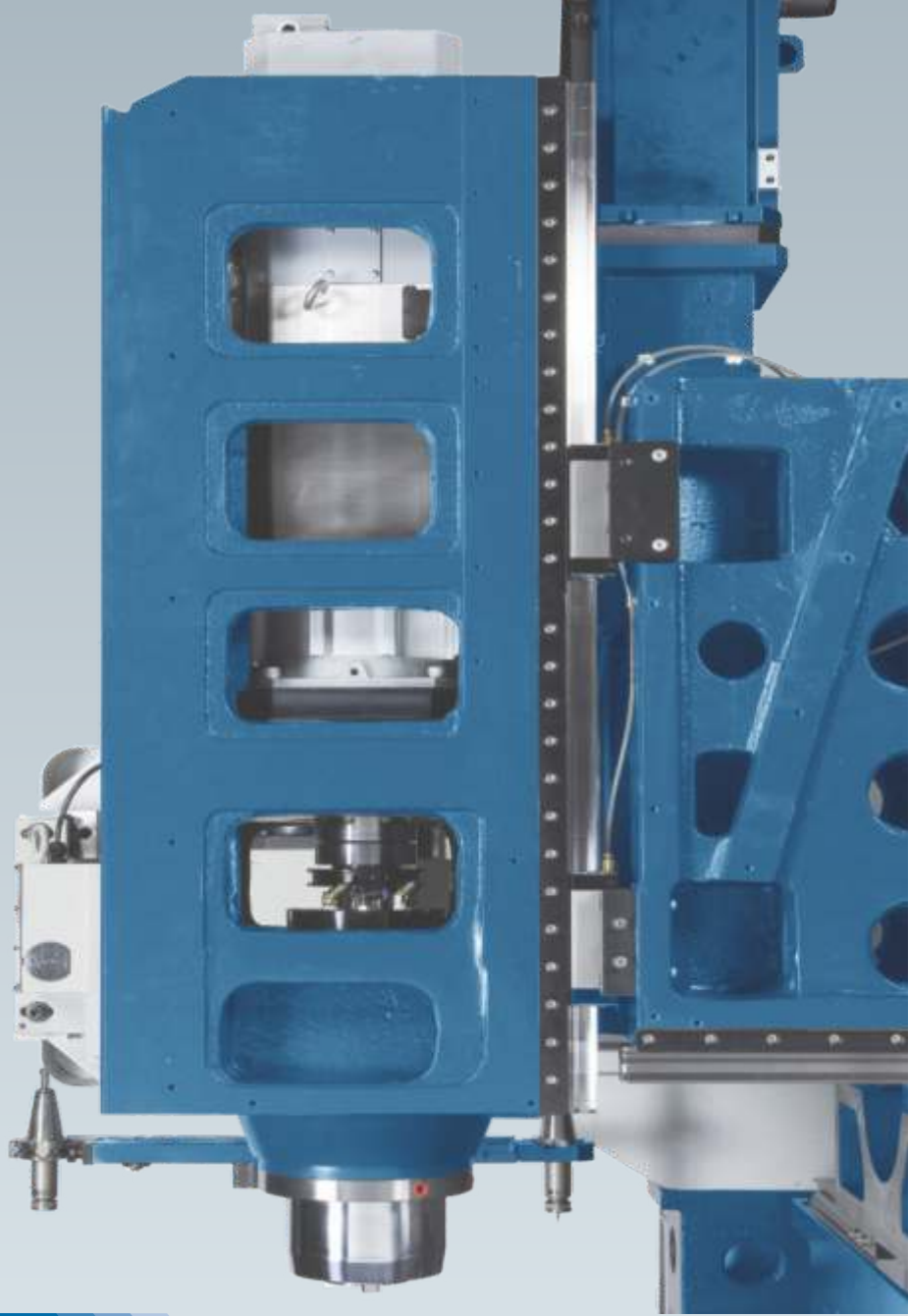

# HEADSTOCK

## Headstock cooling system

Spindle cartridge and clamping flange, between the motor and the cartridge, are cooled by a fluid recirculating system specific for the headstock to ensure thermal and geometric stability for the assembly. Headstock housing has a chamber which involves the cartridge housing for cooling fluid circulation. Cooling system is comprised of one cooling unit (heat - fluid air exchanger) which enables the circulation of cooling fluid in headstock housing to remove

all heating generated by spindle roller bearings. The system reduces the variation of temperature between headstock and immediate surroundings so that the headstock temperature is kept as similar as possible to the ambient temperature. The great benefit of the headstock cooling system is the minimization of thermal distortions of the housing and the assurance of perfect alignment of spindle center line in machining operations which demand high precision of Z axis positioning.

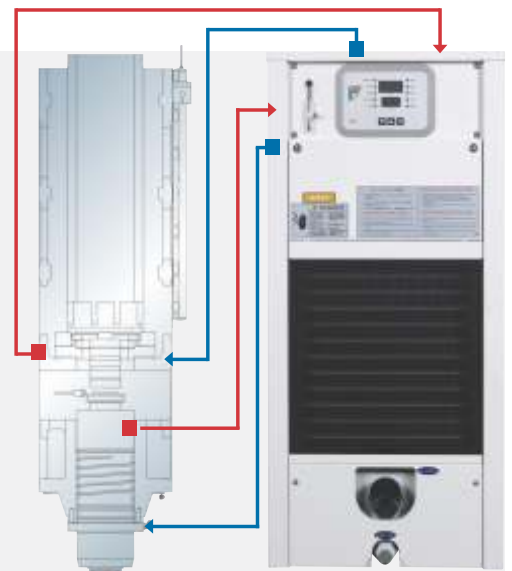





### Linear scale (optional)

X, Y and Z axes can be equipped with linear scale (optional). It provides machine with high precision and repeatability of axes positioning required in machining processes of high complexity parts.

It provides a direct reading of the position where the axis is and send relative signals to the CNC. The reading is real and direct so there is no interference of any possible ball screw error caused by heating or expansion.



### Automatic tool changer

ATC system offers fastness and reliability in tools change. It has a magazine for BT / BBT 40 holders with 30 tools capacity. In order to facilitate tools loading and unloading the machine can be equipped with a lateral door for access to the magazine and an operation panel for manual movement of tools magazine.

## LINEAR ROLLER GUIDES

They offer high load capacity, rigidity and stability even under severe machining conditions. They also enable fast displacements and high accelerations with precision due to low friction coefficient between rails and blocks.

### Linear guides benefits

- High rigidity, high load capacity, long durability
- Fast axes positioning minimizing idle time and improving productivity
- Coolant oil low consumption
- Easy maintenance



### **Datum Sphere** (optional)

It is a effective solution for checking alignment and positioning of rotary axes performance. In just minutes, the machine can identify and notify deficient alignments and geometry which can cause non-compliance of workpieces.

## DATUM SPHERE AND TOUCH PROBE



### **Measure / Inspection of Parts and Optical Receiver System** (optional)

This system allows the user to reduce workpieces setup time, as well as the inspection process, leaving a larger time for machining workpieces effectively.

After a part or device measurement performed, the machine itself performs a self-alignment, because the references of the part program can be rotated according to the position informed read by probe and informed to the CNC.

Enables inspection during machining process to monitor the dimensional and workpiece position, performing an automatic correction if necessary.



**Preset of Tools**  
Dynamic setup of tools.



## PRESET OF **TOOLS SYSTEM** (OPTIONAL)

**Working layout with preset of tools system**  
(optional) - dimensions in mm (in)

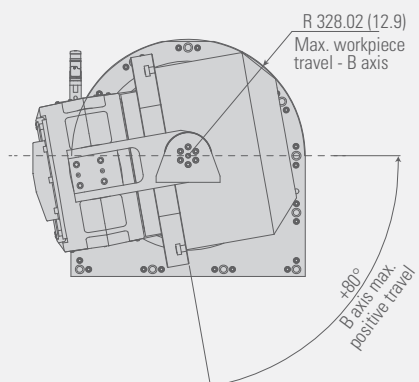

Setup of tools through automatic inspection of diameter and length, automatic compensation of tool wear on Tool Offset CNC screen, reducing significantly the machine setup time (reduction of downtime).

Tool breakage detection during machining processes. Allows the automatic replacement of a worn tool for an equivalent tool available in the ATC, thus avoiding the scrap parts, when associated with life tools manager.

Elimination of errors due to manual entry of tool offset data on OFFSET CNC page.



## CNC

### **CNC Siemens Sinumerik 828D (ROMI DCM 620-5F)**

CNC Siemens Sinumerik 828D offers 15.6" touch screen LCD color monitor, with softkeys to active and select functions, USB port, drive to Compact Flash Card and Ethernet interface for factory network, bringing a great flexibility for loading programs and parameters.

### **CNC Siemens Sinumerik 840D sl (ROMI DCM 620-5X)**

CNC Siemens Sinumerik 840D sl offers 19" LCD color monitor, USB port and Ethernet interface for factory network, bringing a great flexibility for loading programs and parameters

### **Conversational programming programGUIDE**

The programGUIDE facilitates program creation through the input of data in user-friendly screens and animated elements which helps in unequivocal data input. Programming is simplified through drilling, boring, tapping and milling cycles and free-shape profile cuts.



Technical specifications		ROMI DCM 620-5F	ROMI DCM 620-5X
<b>Vertical headstock</b>			
Spindle taper	ISO	40	40
Speed ranges (RPM)	rpm	10 to 10,000	15 to 15,000
<b>Feeds</b>			
Rapid traverse (X / Y / Z axes)	m/min (in/min)	36 (1,417)	36 (1,417)
Max. programmable cutting feed	mm/min (in/min)	1 to 20,000 (0.04 to 787)	1 to 20,000 (0.04 to 787)
Maximum rotation (B and C axes)	rpm	12	12
<b>Travels</b>			
X axis travel	mm (in)	620 (24)	620 (24)
Y axis travel	mm (in)	520 (20)	520 (20)
Z axis travel	mm (in)	460 (18.1)	460 (18.1)
Distance between spindle and table	mm (in)	150 ~ 610 (5.9 ~ 24)	150 ~ 610 (5.9 ~ 24)
Rotation angle - B axis	degrees	-110° ~ +110° (**)	-110° ~ +110° (**)
Rotation angle - C axis	degrees	360°	360°
<b>Rotary table</b>			
Table surface	mm (in)	600 (24) x 600 (24)	600 (24) x 600 (24)
Number of T-slots	un	5	5
T-slot width x distance	mm (in)	18 x 100 (0.71 x 3.9)	18 x 100 (0.71 x 3.9)
Central guide hole	mm (in)	Ø 60 (2.4) H7	Ø 60 (2.4) H7
Max. piece dimension on table	mm (in)	Ø 520 (20) x 330 (13) height	Ø 520 (20) x 330 (13) height
Allowed weight	kg (lbs)	300 (660)	300 (660)
<b>Automatic tool changer</b>			
Tool capacity		30	30
Tool max. diameter	mm (in)	76 (3)	76 (3)
Max. tool diameter when adjacent stations are empty	mm (in)	127 (5)	127 (5)
Max. tool length	mm (in)	250 (9.8)	250 (9.8)
Max. tool weight	kg (lbs)	7 (15)	7 (15)
Max. weight on magazine	kg (lbs)	160 (353)	160 (353)
Tool holder type	type	BT / BBT 40	BT / BBT 40
<b>Power</b>			
Main motor AC (S6 - 40% - 10 min. rating)	hp / kW	24 / 18	24 / 18
Main motor AC (continuous rating)	hp / kW	16 / 12	16 / 12
Total installed power	kVa	50	50
<b>Dimensions and weight (*)</b>			
Height	mm (in)	2,873 (113)	2,873 (113)
Floor space required (front x side)	mm (in)	4,167 x 3,400 (164 x 134)	4,167 x 3,400 (164 x 134)
Net weight	kg (lbs)	9,200 (20,300)	9,200 (20,300)

(\*) Without chip conveyor

(\*\*) Machines equipped with tool preset the angle becomes +80°.

## Standard equipment

- CNC Siemens Sinumerik 840D sl, with 19" color screen (ROMI DCM 620-5X)
- CNC Siemens 828D, with 15.6" color screen (ROMI DCM 620-5F)
- Fully enclosed splash guard
- Thermal compensation
- Complete documentation on CD
- 2 rotary axis with right encoder (B and C) (ROMI DCM 620-5X)
- Linear guides roller for X,Y and Z axis
- Electrical installation for 380 Vca, 50 / 60 Hz
- Set of wrenches for machine operation
- Set of levelling screws and nuts
- Rotary joint for internal cooling
- Sealed worklight LED type
- Support bearing for tilting table
- Manual auxiliary panel, with JOG and handwheel functions for the both axes
- Electric panel with centrifugal climatization and positive pressure
- Wash gun
- Main, side and ATC door with electrical safety switch
- Automatic centralized lubrication system with line filter for linear guides and ball screws
- Coolant system for headstock housing
- Coolant system with 5 bar pump and tank (capacity 200l)
- Pneumatic cleaning system for spindle taper
- Work area cleaning system
- Hydraulic system for tool unclamp
- Automatic tool changer with 30 tools capacity, BT / BBT 40
- Standard colors: 10B-3/4 Munsell blue texture enamel epoxy and textured gray RAL 7035

## Optional equipment

- Longitudinal hinged belt chip conveyor (TCE) (A)
  - Longitudinal drag belt chip conveyor (TCA) (A)
  - Air conditioning for electrical cabinet
  - Autotransformer for 200 - 250 Vca or for 360 - 480 Vca, 30 kVa
  - High pressure pump for thru spindle coolant system (7 bar, 20 bar or 70 bar) (B)
  - Remote diagnosis interface via cable
  - Calibration Ball (D)
  - Angular encoder for B and C axis (ROMI DCM 620-5F)
  - Machining area top cover (C)
  - Oil skimmer
  - Mist exhaust system
  - Filter for mist exhaust system
  - Measure and inspection of parts system with RMP60, radio interface, PS3-1C stylus, D=6mm / L=50mm / M4 and Renishaw software
  - Preset of tools system with Renishaw laser NC4
  - Pneumatic chip cleaning system during machining process
  - Linear scale for X, Y and Z axes
  - Status light indicator
- (A) Mandatory choice  
 (B) For 20 bar and 70 bar pump, requires the "Machining area top cover"  
 (C) Recommended the installation of the accessory "Mist exhausting system"  
 (D) Mandatory the sale of the accessory "Measurement/Inspection of tools system"

## Working layout - dimensions in mm (in)

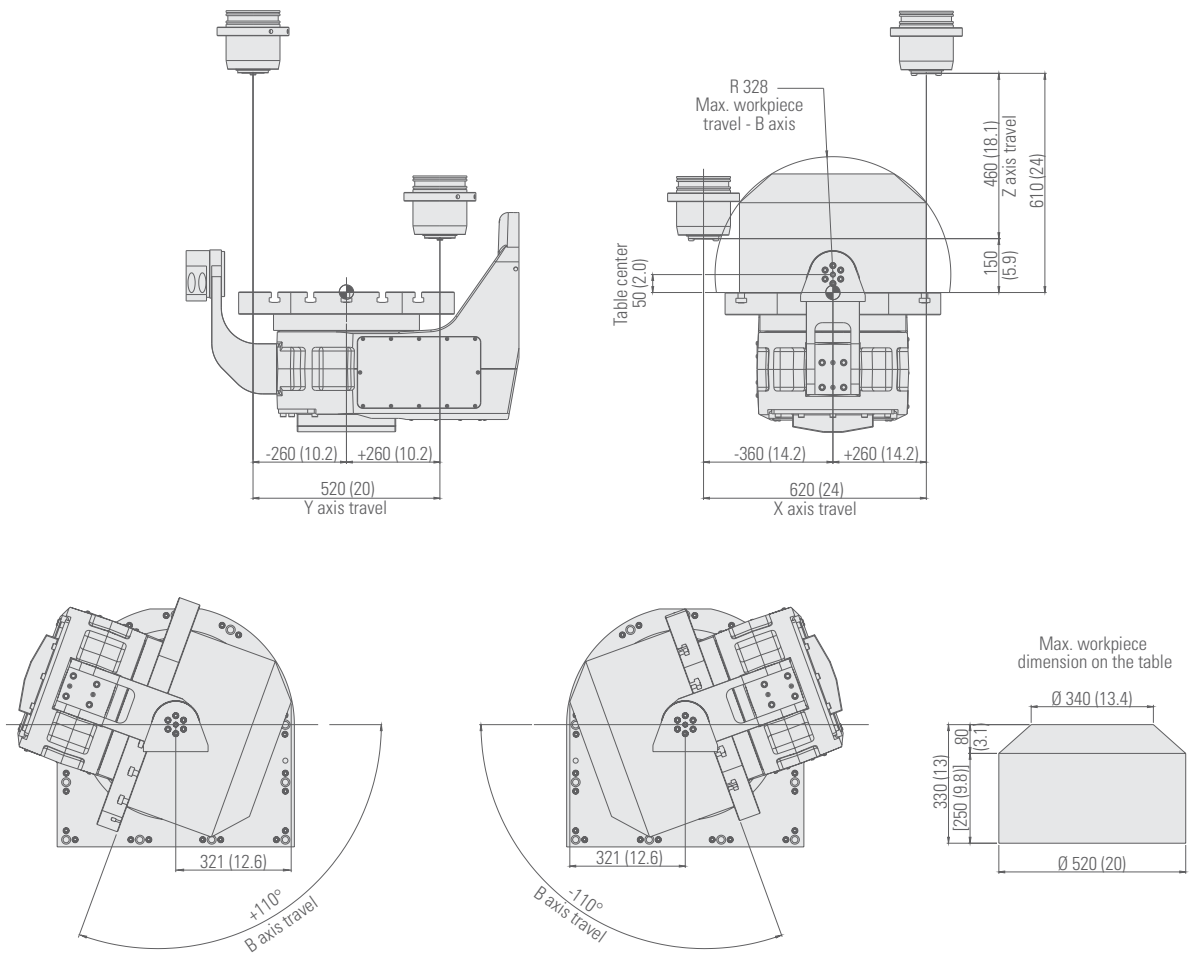

## Table dimensions - dimensions in mm (in)

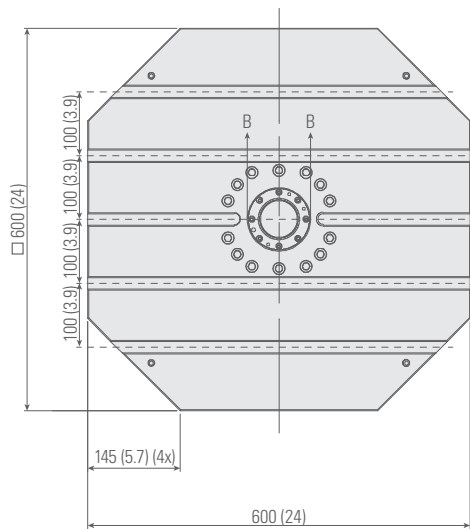

### "T" Slot Detail

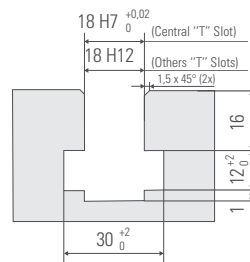

### Central $\varnothing$ detail

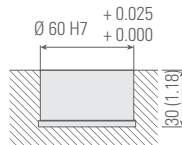

## Holders - dimensions in mm (in)

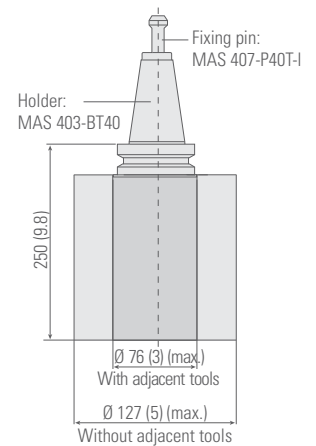

Drawings are not in scale.



## CNC FEATURES - ROMI DCM 620-5F - Siemens 828D

### Resources and cnc performance

- Monitor 15.6"
- Precision 80bit NANOPF
- Advanced Surface for Mold & Die Applications
- Block Execution - ~1 ms
- Look Ahead - 150
- Acceleration with Jerk Control
- Pitch Error
- Synchronous Actions and High Speed Output
- Idioms: Portuguese, English, Spanish, Italian, German, French
- Ethernet Interface
- USB Interface
- CF Card Interface
- Part Number, Machining Cycle Time and Clock
- Calculation Function

### Programming resources:

- Directory Classified by Program, Subprogram and Cycles
- SINUMERIK G code programming with high-level commands
- Cycle of technological support to G-code programs SINUMERIK
- Programming machining ShopMill
- High-speed settings for applications of dies and molds
- Subprogram Call
- Program Block Search
- Background Editing
- Memory Program Number = 300
- Part Program Storage = 5 MB

- Program Load / Save
- Program Creation and Editing
- Linear, Circular and Helical Interpolation
- Rectangular and Circular Bosses Milling
- Circular Pocket
- Rectangular Pocket
- Face Milling
- Profile Milling
- Dwell Time

### Feedrate functions

- 4 axes Simultaneous Control (Rotary table is mandatory)
- Feedrate in mm/ min or pol / min
- Feedrate in mm/ rot or pol / rot
- Feedrate and Precision Position on the Corners
- Exact stop mode

### Graphic functions

- Online Graphic help
- Machining Graphic Simulation
- Kit Graf: 3D simulation / simulation in real time/ Detection of residual material

### Coordinate systems

- Work Plane Selection
- Workpiece Coordinate System = 100
- Machine Coordinate System
- Workpiece Coordinate System Presetting
- Local Workpiece Coordinate System

### Coordinate values and dimensions

- Speed and Dimension in Inch or Metric
- Absolute and Incremental

- Programming Mode
- Linear and Circular Interpolation with Polar Coordinates
- Scale factor
- Mirror /Amirror
- Coordinate System Rotating
- Transfer Zero Point

### Spindle functions

- RPM in S code
- Spindle Angular Positioning (M19 ou Spos)

### Applied tool function

- Tool Radius Compensation
- Tool Length and Radius Manual Measurement
- Tool Offset Compensation Pairs (Length and Diameter) = 512
- Tool Management
- Tool Life Management

### Macro

- Parametric Programming
- Variables of parametric Programming
- System Variables

### Simplification program functions

- Cycle 800 Rotary table
- Canned Cycle for Drilling, Boring and Tapping
- Linear and Circular Pattern for Drilling
- Grid Pattern for Drilling
- Circular Pattern for Straight and Circular Slots
- Circular Pattern for Oblong Milling

- Canned Cycle for Rigid Tapping
- Canned Cycle for Thread Milling
- Floating Tapping
- Engraving Cycle
- Rigid Tapping
- Cylindrical interpolation (Rotary table is mandatory)

### Programming format - 828D

- ISO programming format for the command 828D
- Programming SHOPMILL

### Execution operations

- JOG Mode
- Handwheel Mode
- MDA Operation
- Automatic Mode
- Single Block Mode
- Program Stop Mode
- Optional Stop Mode
- Program Test Operation Mode
- Block Delet Mode
- Axes Referencing by Program
- Tool Retract and Repositioning in JOG Mode (Key REPOS)
- Program Restart
- Automatic Operation by Memory or Remote

### Maintenance functions

- Emergency Stop
- Diagnostics and Alarms Functions

## CNC FEATURES - ROMI DCM 620-5X - Siemens 840D sl

### Resources and CNC Performance

- Resources and CNC Performance
- Monitor 19"
- 80bit NANO FP
- Advanced Surface for Mold & Die Applications
- Block Execution = > 0,5ms
- Look Ahead 250
- Acceleration with Jerk Limitation
- Pitch Error
- Spline Interpolation
- Synchronized Actions
- Transformation with cylindrical radius compensation tool for parallel grooves
- USB
- Ethernet

### MDynamics 5-axis

- Simultaneous Axis Control for 5 Axes
- Advanced Surface - Step II
- Spline Interpolation
- Transmit and peripheral surface transformation
- Measuring cycles
- 3-D simulation/simultaneous Recording
- ShopMill/ShopTurn work step programming
- Detection of residual material
- 5 Axis Machining Package
- 3-D Radius Compensation
- Measure kinematics
- Tool center point programming - TRAORI
- Orientation smoothing with ORISON

### Programming Resources

- SINUMERIK G code programming with high-level commands for flexible scheduling of medium and large groups of parts
- ProgramGuide: cycle of technological support to G-code programs SINUMERIK
- Programming machining ShopMill: efficient programming for individual pieces and small groups of parts

- Interpreter built-in ISO code
- Cycles of technology available for programming and machining ProgramGuide ShopMill
- Boring Cycles
- Machining cycles for standard geometries
- Wide range of standard positions for machining and boring operations
- Write cycle character
- High-speed settings for applications of dies and molds
- Machining cycles for contour pockets / islands with spigots
- Number / research program
- Name of program
- Sub-program
- Program Block Search
- Expanded edition
- Background Editing
- Memory Program Number = 500
- Part Program Storage= 3MB
- Program Creation and Editing
- Program Control
- Reference function

### Feedrate Functions

- Feedrate in mm/min or inch/min
- Feedrate in mm/ rot ou pol / rot
- Dwell time
- Feedrate and Precision
- Position on the Corners
- Exact stop mode
- Cutting Mode
- Continuous tapping mode

### Graphic Functions

- Animated elements - support dynamic cycles
- 3D simulation / simulation in real time
- Detection of residual material
- Measuring cycles
- Quickview Die and Mold
- 3D simulation for multi-axis machining

### Coordinate Systems

- Work Plane Selection
- Workpiece Coordinate System
- Machining Coordinate System
- Local Workpiece Coordinate System
- Workpiece Coordinate System Presetting
- Rotation of the coordinate system

### Coordinate Values and Dimensions

- Programming with decimal point
- Speed and Dimension in Inch or Metric
- Absolute and Incremental Programming Mode
- Polar coordinate
- Scale factor
- Mirror
- Programmable Data Entry

### Spindle Functions

- RPM in S code
- Spindle Angular Positioning (M19 ou Spos)

### Applied Tool Function

- Tool Radius Compensation
- Tool offset Length and Radius Measurement 1500
- Tool Offset Compensation Pairs (Length and Diameter)
- Tool Length and Radius Manual Measurement
- Tool Management
- Function of charge / discharge for simple allocation magazine

### Macro

- Parametric Programming
- VARIABLES of parametric Programming

### Simplification Program Functions

- Canned Cycle for Drilling, Boring and Tapping
- Canned Cycle for Rigid Tapping
- Chamfering and corner rounding

- Programming in mirror image
- Cylindrical Interpolation - TRACYL

### Programming Format - 840D sl Series

- ISO programming format for the command 840D sl

### Execution Operations

- MDA Operation
- Automatic Mode
- Single Block Mode
- Program Stop Mode
- Optional Stop Mode
- Block Delete Mode
- Program restart
- Selection of blocks for execution

### Maintenance Functions

- Emergency Stop
- Diagnostics and Alarms Functions

### Energy Control System

- Control Energy - Efficient Operation of the Machine

# WORLDWIDE PRESENCE

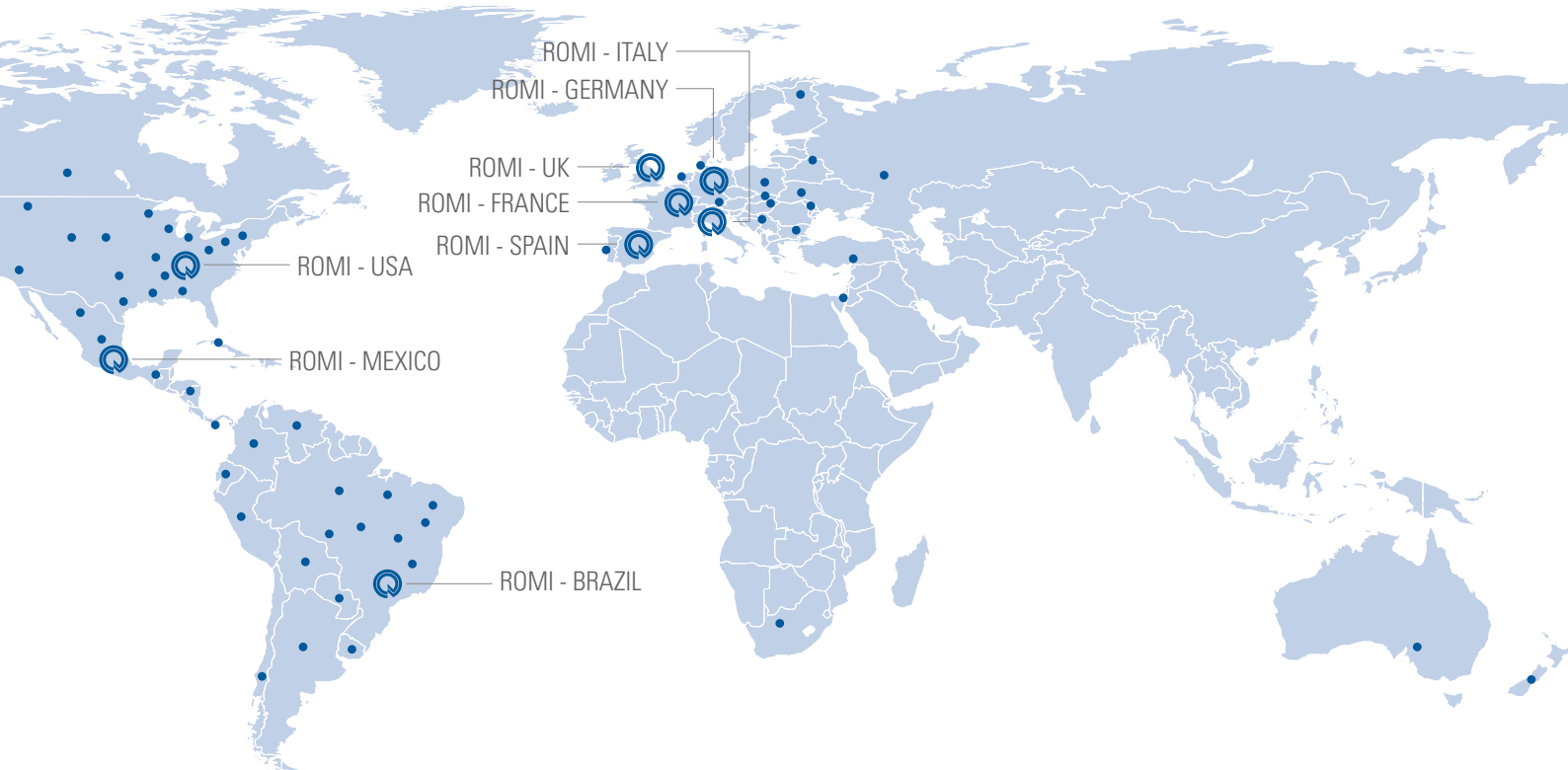

**ROMI**

WWW.ROMI.COM

**ROMI S.A.**  
Rod. SP 304, Km 141,5  
Santa Bárbara d'Oeste SP  
13459 057 Brazil  
+55 (19) 3455 9000

**América Latina**  
+55 (19) 3455 9800  
[export-mf@romi.com](mailto:export-mf@romi.com)

**Burkhardt+Weber  
Fertigungssysteme GmbH**  
Burkhardt+Weber-Strasse 57  
72760 Reutlingen, Germany  
+49 7121 315-0  
[info@burkhardt-weber.de](mailto:info@burkhardt-weber.de)  
[www.burkhardt-weber.de](http://www.burkhardt-weber.de)

**ROMI BW Machine  
Tools Ltd**  
1845 Airport Exchange Blvd  
Erlanger KY – 41018 USA  
+1 (859) 647 7566  
[sales@romiusa.com](mailto:sales@romiusa.com)  
[www.romiusa.com](http://www.romiusa.com)

**ROMI Europa GmbH**  
Burkhardt+Weber-Strasse 57  
72760 Reutlingen, Germany  
+49 7121 315-604  
[sales@romi-europa.de](mailto:sales@romi-europa.de)  
[www.romi-europa.de](http://www.romi-europa.de)

**ROMI France SAS**  
Parc de Genève, 240  
Rue Ferdinand Perrier 69800  
ST Priest  
+33 4 37 25 60 70  
[infos@romifrance.fr](mailto:infos@romifrance.fr)  
[www.romifrance.fr](http://www.romifrance.fr)

**ROMI Machines UK Limited**  
Leigh Road  
Swift Valley Industrial Estate  
Rugby CV21 1DS  
+44 1788 544221  
[sales@romiuk.com](mailto:sales@romiuk.com)  
[www.romiuk.com](http://www.romiuk.com)

**ROMI Máquinas España**  
Calle Comadrán, 15  
Pol. Ind. Can Salvatela  
C.P. 08210 - Barberà del Vallès  
+34 93 719 4926  
[info@romi.es](mailto:info@romi.es)  
[www.romi.es](http://www.romi.es)

**ROMI en México**  
Condominio Parque Arista, Calle  
Gral. Mariano Arista 54, bodega 19  
  
C.O. 11230, CDMX, México  
+521 55 9154 5851  
[ventasmx@romi.com](mailto:ventasmx@romi.com)  
[www.romimexico.com](http://www.romimexico.com)

**ROMI Italia Srl**  
Via Morigi, 33-29020  
Gossolengo (PC) - Italia  
+39 0523 778 956  
[commerciale@romiitalia.it](mailto:commerciale@romiitalia.it)  
[www.romiitalia.it](http://www.romiitalia.it)



**ISO 9001:2015**  
Certificate No. 31120



**ISO 14001:2015**  
Certificate No. 70671

**CE safety regulation compliance available only for the European Community or under request.  
Check availability and technical characteristics of the products to your country.**